

A MTCA BASED BPM-SYSTEM FOR PETRA IV

G. Kube, H.-T. Duhme, J. Lamaack, F. Schmidt-Föhre, K. Wittenburg
Deutsches Elektronen-Synchrotron DESY, Germany

A. Bardorfer, L. Bogataj, M. Cargnelutti, P. Leban, M. Oblak, P. Paglovec, B. Repič
I-Tech, Solkan, Slovenia

Abstract

The PETRA IV project at DESY aims to upgrade the present PETRA III synchrotron into an ultra low-emittance source. The small emittances translate directly into much smaller beam sizes, thus imposing stringent requirements on the machine stability. In order to measure beam positions and control orbit stability to the level of 10% of beam size and divergence, a high resolution BPM system will be installed which consists of 788 individual monitors with the readout electronics based on MTCA.4. In order to fulfil the long-term drift requirement ($< 1 \mu\text{m}$ over 7 days), several analog, digital and SW parts were taken from the Libera Brilliance+ and a new RTM module has been developed to be used as BPM electronics RF frontend (RFFE). In addition, its analogue RF switch matrix used for long-term stabilization was separated and placed close to the BPM pickup, hence enabling an additional drift stabilization of the acquired RF input signals against environmental and other impact along the RFFE cables. At present, a fully populated MTCA crate with 6 AMC boards for the readout of 12 BPMs is installed at PETRA III and is extensively being tested. This contribution summarizes the latest beam measurements, showing the achieved performance of the BPM system.

INTRODUCTION

The PETRA IV project at DESY (Hamburg, Germany) aims at the construction of a diffraction limited ultra-low emittance light source operating at 6 GeV [1, 2]. The PETRA IV storage ring will be built in the existing PETRA III tunnel, thus inheriting the original 8-fold symmetry of the former PETRA collider. The accelerator lattice is based on a modified hybrid six-bend achromat (H6BA) cell and, taking advantage of the 2.3 km circumference, it provides electron beams with 20 pm rad emittance. The facility layout is shown in Fig. 1, the PETRA IV design operational parameters are summarized in Table 1.

Table 1: PETRA IV Main Parameters

Parameter	Value
energy	6 GeV
circumference	2304 m
emittance	20 pm rad
rel. energy spread	0.91×10^{-3}
momentum compaction	3.3×10^{-5}
$\beta_{x,y}$ at IDs	2.2 m, 2.2 m

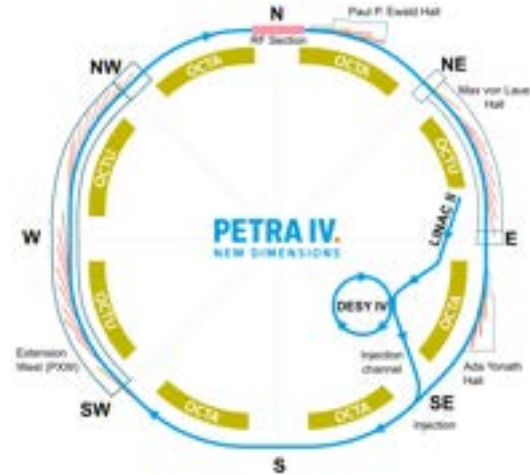

Figure 1: Layout of the PETRA IV facility.

The small beam emittances translate directly into much smaller beam sizes of about $7 \mu\text{m}$ horizontally and $3 \mu\text{m}$ vertically at the insertion device source points, thus imposing stringent requirements on the machine stability. In order to measure beam positions and control orbit stability to the level of 10% of beam size and divergence, a high resolution BPM system will be installed which consists of 788 individual monitors with the readout electronics based on MTCA.4 as technical platform.

In the beam commissioning phase of a storage ring, the BPM accuracy is essential. Before any beam accumulation in the ring will be possible, the BPM measurement accuracy must satisfy the requirements for the beam-based alignment (BBA) procedure, i.e. offset errors between the magnetic axes of the nearby quadrupoles and the electric centers of the BPMs must be identified. These offsets comprise alignment tolerances as well as electric and electro-mecanical offsets

Table 2: Readout electronics specifications. The single bunch / turn resolution holds for 0.5 mA bunch current, the closed orbit one for 1 kHz bandwidth, the beam current dependency for a 60 dB range with centered beam, and the long term stability should be measured over 6 days and a temperature span of $\pm 1^\circ\text{C}$ within a stabilized rack.

Requirement	Value
single bunch / single turn	$< 10 \mu\text{m}$
closed orbit resolution	$< 100 \text{ nm (rms)}$
beam current dependence	$\pm 2 \mu\text{m}$
long term stability	$< 1 \mu\text{m}$

Content from this work may be used under the terms of the CC-BY-4.0 licence (© 2023). Any distribution of this work must maintain attribution to the author(s), title of the work, publisher, and DOI

and are discussed elsewhere. After commissioning and in the user operating phase when orbit and optics corrections are complete, BPM resolution and beam stability are of greatest importance. In this case all random errors that change over time are of relevance. These errors are mainly affected by the BPM readout chain which will be covered in this report, the corresponding specifications are summarized in Table 2.

In order to fulfil the requested long-term drift requirement for PETRA IV, the specific machine geometry with the infrastructure distributed in the former experimental halls has to be taken into account, resulting in long cable lengths between monitor and readout electronics. With these long cables it is not guaranteed that cable routing will be in a perfectly stabilized temperature and humidity environment, thus affecting the BPM position readings [3, 4]. Therefore, in order to fulfil the requested long-term drift stability the BPM cable paths have to be stabilized in addition. Different drift compensation schemes are available and reviewed in Refs. [5, 6], the most popular one is the well proven concept of crossbar switching [7, 8] which stabilizes the analogue RF frontend part of the system. Another concept which has gained in popularity in recent years is the pilot tone (PT) compensation method where a sinusoidal PT signal with fixed frequency close to the carrier is injected in the signal chain. This signal is used as reference for calibration and compensation, see e.g. Refs. [9–12].

A series of test measurements at PETRA III indicated that the PT method works well with a homogeneous fill pattern, however the compensation was less effective for few bunch mode operation due to an overlap of PT and beam signals in the frequency domain [13]. According to this finding and following the discussion in Ref. [6], for PETRA IV it was decided to extend the standard crossbar switching method and come up with the idea of external crossbar switching where the analogue switching part is separated from the readout electronics and brought as close as possible to the BPM pickup, thus stabilizing also the cable paths. Based on this idea, DESY and the company *I-Tech* started a cooperation within the PETRA IV Technical Design Report (TDR) phase with the objectives to develop and test a MTCA.4 based BPM system with the extended stabilization scheme. The external crossbar switching method was tested successfully on a prototype at DESY. In a series of measurements performed at PETRA III with a modified Libera Brilliance+ (LB+) [14] and external switching matrix it was demonstrated that this concept works well and that the performance of the modified setup fulfils the specifications, see Refs. [15, 16]. Afterwards the readout electronics was ported to be compatible with the MTCA.4 standard, the prototype system evaluation under laboratory tests is described in Ref. [17].

This contribution summarizes the results from first beam measurements at PETRA III. A fully populated MTCA crate with 6 AMC boards for the readout of 12 BPMs is presently installed in the machine and extensively being tested. In the subsequent section a brief description of the MTCA.4 based readout system will be given, and afterwards the status of the investigations at PETRA III is presented.

SYSTEM DESCRIPTION

The signal chain of two BPMs together with their related electronic boxes (containing the 4x4 RF crossbar switch *Libera XBS FE* together with analog RF signal conditioning circuits) and RF frontend cabling is shown in Fig. 2. The signals from two BPMs are processed by an analog/digital RTM and a digital AMC board. It is planned to use a maximum of 6 modules per crate, corresponding to 12 BPMs. The AMC board serves as signal interface between MTCA backplane and the outer world as well as for the incoming raw BPM data from the four 2-channel ADCs on the RTM module. The COTS AMC board (CAENels FMC2ZUP) is optionally planned to be replaced by a specialized version, currently under development at DESY.

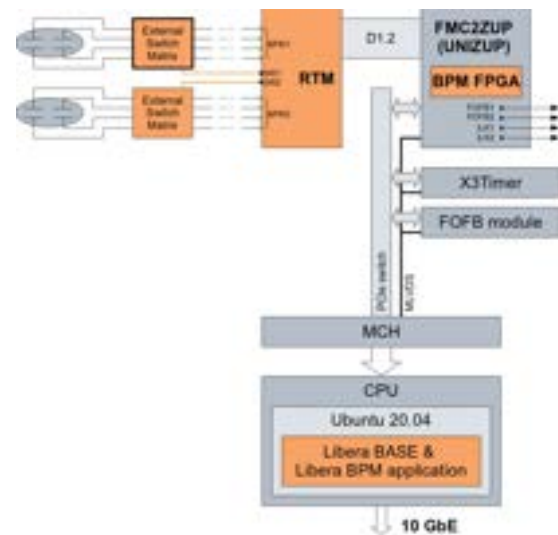

Figure 2: BPM system building blocks and interconnections. Courtesy: I-Tech.

The RTM board developed by I-Tech holds the analog RFFE of both BPMs from the signal cable output of the two external switching boxes up to the analog/digital backend of the ADC data chain together with additional glue logic for the control of the ADCs, up to two external switching boxes, and a couple of internal sensors. The encapsulation of the longest RF signal path between the *Libera XBS FE* and the ADC on the RTM module ensures a maximum of low-perturbation RF input signal integrity up to the digital domain.

Specialized turn-by-turn data streams at bunch revolution frequency ($f_0 \sim 130.1$ kHz) for the fast orbit feedback (FOFB) connect each BPM module inside the crate over a specialized data aggregation backplane (star topology) with a dedicated FOFB data aggregation module. Central timing signals are delivered to the boards via a timer module (X3Timer) using clock and trigger lines on the backplane according to the MTCA standard. BPM channel related interlock alarm signals (ILK) can be produced by each AMC module. BPM-related software and firmware required for configuration, status evaluation and data management of all BPM channels inside the MCTA crate is distributed on each

of the RTMs and AMCs as well as on the crate CPU. All data exchange between CPU and distinct BPM modules are accomplished over high-speed PCIe connections.

Besides the Linux OS, the CPU software hosts the common control system specific data infrastructure as well as BPM-specific software parts. The BPM-specific application core (*libera-ebpm*, *Libera Base* and *libera kernel*) contains the specific crate configurations, the BPM-specific adaption layer (*libera-mci*) and an adapted interface to the DOOCS control system. It is completed by less execution time critical functional software blocks for the BPM application of all channels inside the crate.

Time critical functional blocks for the BPM application are implemented inside the application-specific parts of the programmable logic FPGA firmware on each AMC board for fast execution. In addition, minimal housekeeping data is acquired from several onboard sensors for long-term operation safety under typical environmental conditions. A small micro controller on the RTM serves for RTM-specific low-level board control purposes.

Each BPM channel is able to deliver basic data structures: (1) a local slow acquisition (SA) beam position information in a continuous 10 Hz data stream; (2) a fast acquisition (FA) data structure acquired on-demand (i.e. externally triggered) at 10 kHz; (3) ADC raw data blocks sampled at approximately 117 MHz; (4) turn-by-turn (TbT) data blocks which alternatively can be derived via digital down conversion (DDC) or time domain processing (TDP) at bunch revolution data rate f_0 ; (5) a special MultiTbT data structure which will be available for dedicated operating conditions that profit from segmentation of the TbT acquisition window. For first turn steering during the commissioning phase, either TbT or single pass data can be utilized, the latter ones having the advantage of an improved signal-to-noise ratio.

In order to test the new readout system, a fully populated MTCA crate was installed in PETRA. The signals of 12 BPMs were split and fed to both, the existing PETRA III *Libera Brilliances* and the new MTCA based system, hence allowing a direct comparison of their performance. Figure 3 shows the installation of the new readout system in the accelerator.

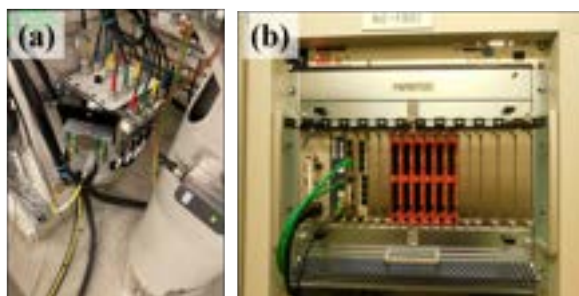

Figure 3: BPM readout system installation in PETRA III: (a) *Libera XBS FE* crossbar switch matrix installation in the tunnel and patch panel for signal splitting; (b) MTCA crate in the electronics cabinet equipped with 6 AMC boards, MCH, CPU, timing and fan module.

MEASUREMENTS

A series of measurements was performed at PETRA III using 480 bunches with 120 mA stored beam current during top-up operation, a similar mode is also planned for PETRA IV. For each BPM under test the data paths described before were investigated. As an example, Fig. 4 shows the horizontal power spectral density (PSD) derived from the FA data path using a BPM close to an undulator. Besides the influence of the notch filter at 3.3 kHz which is implemented in all *Liberas*, the influence of the top-up injection in PETRA III is clearly visible and can be eliminated by gating-out the injection. Nevertheless, a number of characteristic frequency lines is still present which consist mainly of higher harmonics of 50 Hz.

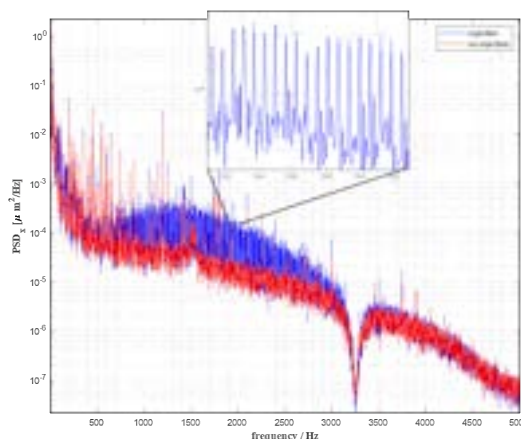

Figure 4: Horizontal power spectral density, derived from the FA data path at 10 kHz sampling rate. The blue curve was recorded under standard operational conditions. The detail enlargement shows a series of frequency lines equally spaced by 6.25 Hz. This frequency is characteristic for the top-up injection in PETRA III. For the red curve the injection was gated-out.

As can be concluded from this but also from other measurements using different data paths, the beam stability in PETRA III is not sufficient to explore the resolution limits of the readout electronics. Hence, in order to get rid of the beam jitter it was decided to exclude one of the BPMs under test from the orbit measurement and place 2 four-way splitters in the signal paths behind 2 pickup antennas. The output cables from one splitter were connected to the MTCA system, the signals from the other one to a *Libera Brilliance* under test. After the installation in September 2023 a new series of measurements was performed, investigating only a single BPM with beam jitter cancellation.

Figure 5 shows the horizontal PSD based on FA data together with the closed orbit resolution as function of bandwidth. As can be seen, the PSD is free from spurious lines except the one at about 3.5 kHz, mainly caused due to down-mixing of a crossbar switching frequency. The rms resolution for the bandwidth from DC to 1 kHz amounts to 70 nm (monitor constant $K_x = 10$ mm). Assuming a constant of K_x

Content from this work may be used under the terms of the CC-BY-4.0 licence (© 2023). Any distribution of this work must maintain attribution to the author(s), title of the work, publisher, and DOI

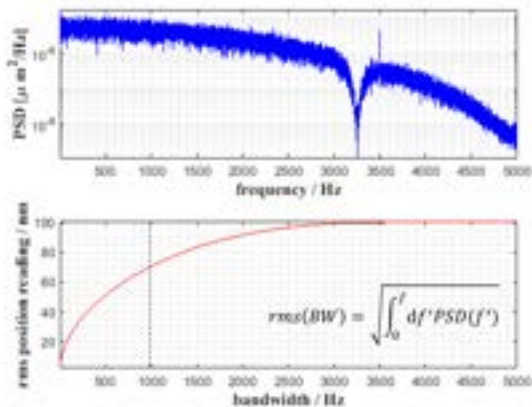

Figure 5: Horizontal power spectral density and closed orbit resolution as function of bandwidth, derived from the FA data path for the BPM with beam jitter cancellation. The monitor constant is $K_x = 10$ mm.

= 7.1 mm which is the case for the PETRA IV standard arc BPMs, the resolution is about 50 nm which is well below the specification of < 100 nm according to Table 2. The measured resolution is comparable to the one from a *Libera Brilliance+* [15], indicating that their system performances are equivalent.

Using the TbT data stream instead of FA data, the rms resolution in the requested bandwidth up to 1 kHz is well reproduced. Moreover, this data stream is also available from the existing PETRA III *Libera Brilliances*, hence allowing a direct comparison of both systems. Assuming again a monitor constant of 10 mm, the rms resolution in the full bandwidth from DC to $f_0/2$ amounts to 1 µm for the *Libera Brilliance*, and to 300 nm for the new MTCA based system, thus demonstrating the performance improvement.

In order to investigate the long term stability, the SA data path with 10 Hz sampling rate is of importance. For the time being the measurement period was set to only 1.5 days, later on it will be extended to the required 6 days according

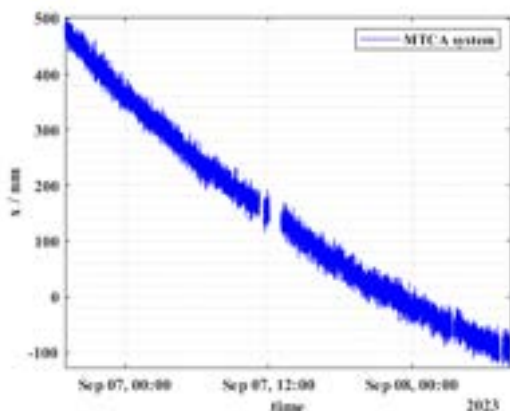

Figure 6: Horizontal position readings acquired from the SA data path with the MTCA based system and monitor constant $K_x = 10$ mm. Gaps in the data indicate periods where the beam was lost.

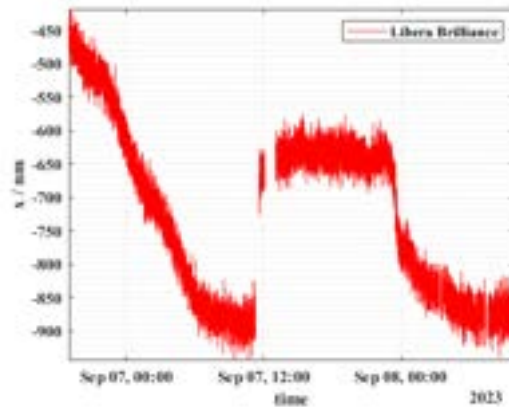

Figure 7: Horizontal position readings acquired from the SA data path with a *Libera Brilliance* under the same conditions than in Fig. 6.

to Table 2. As can be seen in Fig. 6 the horizontal position readings show a smooth drift which is in the order of 600 nm. Figure 7 shows a simultaneous measurement but with a *Libera Brilliance*, indicating a drift of about 1.35 µm. From the comparison it is clear that the drift behaviour of the MTCA based system is smaller, especially the external crossbar switching seems to cope better with sudden environmental changes as in the case of a beam loss where the heat load in the tunnel changes on a short timescale. Nevertheless, the remaining drift in the MTCA based long term measurement has to be minimized. From the experience with the proof-of-principle setup described in Refs. [15, 16] it is assumed that this drift is caused by the measurement setup itself and not by the readout electronics. Especially the signal cables between 4-way splitter and crossbar switching matrix are uncompensated and therefore extremely sensitive to any kind of variations. However, this needs to be proven and will be topic of upcoming investigations.

SUMMARY AND OUTLOOK

This paper summarizes first performance evaluations of a MTCA based BPM readout system relying on the concept of external crossbar switching at PETRA III. The system is continuously in operation since end of 2022 without any downtime. For a measurement exploiting the resolution limit of the electronics it is evident to exclude any kind of beam jitter. Under this condition it is demonstrated that the new system fulfils the closed orbit resolution specification for PETRA IV, indicating the performance improvement compared to the existing *Libera Brilliance* based PETRA III system.

While the long term stability of the new system is better compared to the *Libera Brilliance* and below the specification limit of < 1 µm, the measured drift behaviour suggests an influence of the uncompensated signal path as it was experienced at earlier stages using a proof-of-principle setup.

In the next step this long term drift behaviour will further be investigated and improved, and the readout system will be tested in view of the remaining specifications in Table 2.

REFERENCES

- [1] C.G. Schroer *et al.*, “PETRA IV: upgrade of PETRA III to the Ultimate 3D X-ray microscope”, Conceptual Design Report PUBDB-2019-03613, DESY, Germany.
doi:10.3204/PUBDB-2019-03613
- [2] R. Bartolini *et al.*, “Status of the PETRA IV Machine Project”, in *Proc. IPAC’22*, Bangkok, Thailand, Jun. 2022, pp. 1475–1478.
doi:10.18429/JACoW-IPAC2022-TUPOMS029
- [3] G. Rehm and C. Bloomer, “Impact of Relative Humidity on EBPM Readings”, talk presented at 2nd Diagnostics Experts of European Light Sources Workshop (DEELS’15), Cerdanyola del Vallès, Spain, June 2015.
<https://indico.cells.es/event/22/>.
- [4] N. Hubert, “Test of BPM Cables vs Humidity and Temperature”, talk presented at 6th Diagnostics Experts of European Light Sources Workshop (DEELS’19), Grenoble, France, June 2019. <https://indico.cern.ch/event/789811/>.
- [5] G. Rehm, “Review of BPM Drift Effects and Compensation Schemes”, presented at the IBIC’22, Kraków, Poland, Sep. 2022, paper MO3I1, unpublished.
- [6] F. Schmidt-Foehre, G. Kube, and K. Wittenburg, “Comparison of Two Long Term Drift Stabilization Schemes for BPM Systems”, in *Proc. IBIC’21*, Pohang, Korea, Sep. 2021, pp. 145–149. doi:10.18429/JACoW-IBIC2021-MOPP36
- [7] U. Mavrič, “Innovative RF Design Unites Benefits of Multiplexed and Multi-channel System”, in *Proc. 4th Beam Instrumentation Workshop (BIW’04)*, Knoxville, TN, USA, May 2004, pp. 373–378.
- [8] A. Kosicek, “Libera Electron Beam Position Processor”, in *Proc. 21st Particle Accelerator Conf. (PAC’05)*, Knoxville, TN, USA, May 2005, paper RPAT093, pp. 4284–4286.
- [9] J. Mead *et al.*, “NSLS-II RF Beam Position Monitor Commissioning Update”, in *Proc. 3rd Int. Beam Instrumentation Conf. (IBIC’14)*, Monterey, CA, USA, Sep. 2014, paper WECYB2, pp. 500–504.
- [10] G. Brajnik, S. Carrato, S. Bassanese, G. Cautero and R. De Monte, “Pilot tone as a key to improving the spatial resolution of eBPMs”, in *Proc. AIP Conf.*, vol. 1741, p. 020013, 2016. doi:10.1063/1.4952792
- [11] M. Cargnelutti, S. Bassanese, G. Brajnik, S. Cleva, R. De Monte, and P. Leban, “Stability Tests with Pilot-Tone Based Elettra BPM RF Front End and Libera Electronics”, in *Proc. 7th Int. Beam Instrumentation Conf. (IBIC’18)*, Shanghai, China, Sep. 2018, pp. 289–292.
doi:10.18429/JACoW-IBIC2018-TUPB13
- [12] G. Brajnik and B. Repič, “Current Status of Elettra 2.0 eBPM System”, presented at *Libera Workshop 2021*.
- [13] G. Kube, “BPM Studies in view of PETRA IV”, presented at *15th Libera Online Workshop*, June 17, 2020.
- [14] Libera Brilliance+, <https://www.i-tech.si/products/libera-brilliance-3/>.
- [15] G. Kube *et al.*, “Tests of the New BPM Long Term Drift Stabilization Scheme Based on External Crossbar Switching at PETRA III”, in *Proc. IBIC’21*, Pohang, Korea, Sep. 2021, pp. 123–127. doi:10.18429/JACoW-IBIC2021-MOPP30
- [16] G. Kube *et al.*, “Upgrade of the BPM Long Term Drift Stabilization Scheme Based on External Crossbar Switching at PETRA III”, in *Proc. IBIC’22*, Kraków, Poland, Sep. 2022, pp. 395–398. doi:10.18429/JACoW-IBIC2022-WEP08
- [17] P. Leban *et al.*, “Preliminary Evaluation of the MTCA.4 BPM Electronics Prototype for the PETRA IV Project”, in *Proc. IBIC’22*, Kraków, Poland, Sep. 2022, pp. 399–402.
doi:10.18429/JACoW-IBIC2022-WEP09